



Determination of the Thermal Neutron Flux by Measuring Gamma Radiations with High and Low Resolution Detectors

M. M. Hosamani, A. S. Bennal and N. M. Badiger*

Department of Studies in Physics Karnatak University, Dharwad-580001, India

*Email: nbadiger@gmail.com

ARTICLE INFORMATION

Received: November 15, 2018
 Revised: April 20, 2019
 Accepted: May 27, 2019
 Published online: June 5, 2019

Keywords:

Thermal neutron flux, Neutron irradiation,
 Indium foil activation, Cadmium difference
 method

ABSTRACT

Thermal neutron flux (Φ_{th}) of Americium-Beryllium (Am-Be) neutron source has been measured by adopting the foil activation method. The neutrons emitted from Am-Be source are used to activate the indium-115 (^{115}In) foil. The gamma radiations emitted from the activated isomer $^{116m1}\text{In}$ are measured with NaI(Tl) and HPGe detectors. The thermal neutron flux is measured by adopting the cadmium (Cd) foil difference technique in which the Cd foil placed in front of the source to prevent the thermal neutrons from entering into the indium foil. The neutron flux is determined by measuring the gamma radiation emitted from indium foil using a low and high energy resolution NaI(Tl) and HPGe detectors respectively. The measured thermal neutron flux obtained from both detectors has been compared and found that the Φ_{th} does not depend on the resolution and type of the detectors used in the present investigations.

DOI: [10.15415/jnp.2019.62027](https://doi.org/10.15415/jnp.2019.62027)

1. Introduction

It is well known that the neutron is an uncharged particle and does not interact directly with the electrons of matter and hence it difficult to detect directly. Indirect methods such as recoil technique and nuclear reaction are used for detection purposes which are shown in Table 1. In foil activation technique the neutron is absorbed by the nucleus to form a compound nucleus. The compound nucleus emits particles such as beta, gamma or charged particles which are detected to establish the neutrons interactions with the foil. The foil activation technique by neutron has been reported as one of the best techniques to measure the thermal neutron flux of the neutron sources.

In the present investigations we have used neutron activation technique to measure the neutron flux using low energy resolution NaI(Tl) detector and high resolution HPGe detector. Neutrons can be generated by several methods like nuclear reaction, nuclear reactors, spontaneous fission, photo-neutron source and alpha-beryllium source [1]. The Am-Be is one of the sources which emits neutrons from thermal neutrons (~ 0.025 eV) to fast neutrons (~ 10 MeV) [2]. The standard neutron energy spectrum of the Am-Be source is shown in Figure 1. In this source, the alpha particles of 5.486 MeV from ^{241}Am incident on ^9Be foil which has relatively loosely bound neutron with binding

energy of 1.7 MeV and the neutrons are emitted through the following reaction.



The Am-Be neutron source which has activity of 10^5 neutrons per second [3], stored in a 15 inch \times 10 inch cylindrical paraffin container for the safety shielding.

2. Theory

The stable isotope of ^{115}In is irradiated by neutrons emitted from Am-Be source to form radioactive indium isomers such as ^{116}In , $^{116m1}\text{In}$ and $^{116m2}\text{In}$ with half lives 14.1 second, 54.2 minute and 2.18 second respectively [4]. The properties of activated indium isomers are shown in Table 2. From the table, it is noted that the half lives and cross sections for formation of the ^{116}In and $^{116m2}\text{In}$ are short and low [5], and hence we have not considered these two nuclei in present work. By using cadmium difference method, the thermal neutron flux of Am-Be is evaluated by considering $^{116m1}\text{In}$ isomer only. The formation and decay of $^{116m1}\text{In}$ is shown in Table 2.



It is worth mentioning that $^{116m1}\text{In}$ has high neutron absorption cross section for thermal neutron and it is having half life of 54.2 minute.

When thin indium foil of mass (m), irradiated for time ($t_i = 7200$ s) and it becomes a radioactive. The activated indium foil is kept to cool for some time to avoid the

contribution of ^{116}In and $^{116m2}\text{In}$ [5] and this time is called delay time ($t_d = 300$ s). The nuclear radiation emitted from the activated foil is measured for time ($t_c = 3600$ s) by using gamma spectrometers like High Purity Germanium (HPGe) and NaI(Tl) detectors to determine thermal neutron flux of the Am-Be neutron source.

Table 1: The neutron measurement through secondary particle detection technique [13]

Reaction	$^3\text{He}(n, p)$	$^6\text{Li}(n, \alpha)$	$^{10}\text{B}(n, \alpha)$
Products	$^3\text{He} + p$	$^3\text{He} + \alpha$	$^7\text{Li} + \alpha$ (6 %) $^7\text{Li} + \alpha$ (94 %)
Q - Value [MeV]	0.76	4.78	2.79 2.31
Cross section [barns]	5330	937	3837
Abundance	0.014 %	7.6 %	19.9 %

Table 2: The properties of the activated ^{115}In isomers

Isomers of ^{115}In	Half life $t_{1/2}$	Energies of emitting γ [keV]	Reaction cross section Q [barns]	Qgs - Decay [keV]	Branching ratio	Daughter
^{116}In	14.1 [s]	1293	0.11	462.81	β^- 99.97 % EC 0.023 %	$^{116}_{48}\text{Cd}$
$^{116m1}\text{In}$	54.2 [min]	417 1097 1293	0.802	3403.51	β^- 100 %	$^{116}_{50}\text{Sn}$
$^{116m2}\text{In}$	2.18 [s]	162	0.310	289.66	IT 100 %	$^{116}_{49}\text{In}$

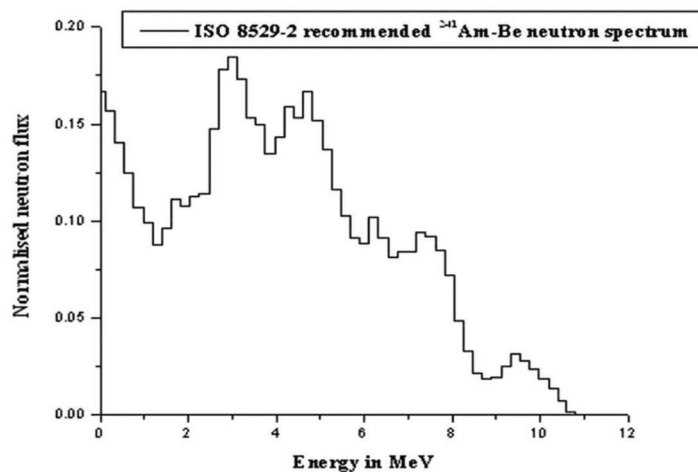

Figure 1: Neutron energy spectrum of Am-Be source

3. Experimental Technique

The stable ^{115}In foil of thickness 1 mm, size of 2.5 cm X 2.5 cm and mass of 4.6 gm with purity 99.9 % has been used for

neutron irradiation. The Am-Be neutron source emits the neutrons in the range from thermal to fast [6]. However, our objective is here to measure the flux of thermal neutrons only.

Therefore in the present work, we have used an appropriate Cd foil of thickness 0.273 mm to stop the thermal neutron to enter into the indium foil and only epithermal and fast neutrons are allowed to activate the indium foil. Using Cd foil difference method, we have determined the thermal neutron captured gamma radiation emitted from activated indium foil. The gamma rays emitted from $^{116m1}\text{In}$ have been measured using low and high resolution gamma ray spectrometers.

3.1 Thermal neutron flux measurement using HPGe detectors

To measure the thermal neutron flux we have used the foil activation technique; here the neutrons emitted from the Am-Be source are made to interact with ^{115}In foil. The activated indium has three isomers namely ^{116}In , $^{116m1}\text{In}$ and $^{116m2}\text{In}$. Of these $^{116m1}\text{In}$ has the long lifetime of about 54.2 min. In the present study the gamma radiation emitted from $^{116m1}\text{In}$ are used to determine the neutron flux. We have used ORTEC made HPGe detector (GMXIOP) which has detector crystal diameter of 4.96 cm, length 4.71 cm. This detector is covered with beryllium window of thickness 0.5 mm. The HPGe detector has an energy resolution of 564 eV and 1.77 keV at 5.9 keV and 1.33 MeV, respectively. The experimental arrangement for neutron flux measurement is shown in Figure 2. The output of the HPGe detector is fed to the ORTEC amplifier and then to 16K multi-channel analyzer (MCA). We have calibrated the detector using the calibrated radioactive gamma sources such as; ^{137}Cs , ^{22}Na and ^{60}Co . The calibration curve is shown in Figure 3, and the calibration constant comes out to be 0.409 keV/Channel. By measuring the intensity of gamma rays with HPGe detector the neutron flux is determined using following equation [4].

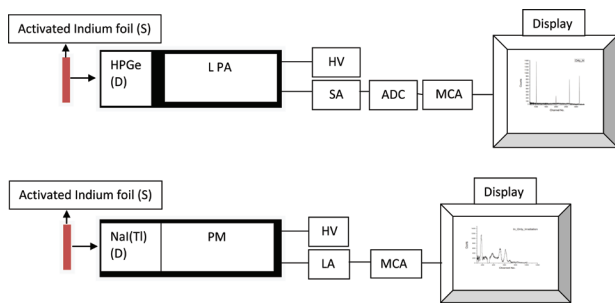

Figure 2: Experimental arrangements

$$\Phi_{th} = \frac{N_o \lambda}{N_T \sigma_{th} \epsilon I_s (1 - e^{-\lambda t_i}) e^{-\lambda t_d} (1 - e^{-\lambda t_c})} \quad (1)$$

where N_o is the difference in counts recorded by HPGe detector without and with placing the Cd foil in front of

indium foil during the irradiation. The typical spectra of gamma radiation recorded by the detector without Cd and with Cd are shown in Figure 4. The λ is the decay constant, ϵ is the efficiency of the detector, σ_{th} is thermal neutron absorption cross section for indium foil which is 202 barns [5, 13], I_s is the absolute gamma ray intensity 29.2 % [6, 7] and N_T is the number of target nuclei which is given by

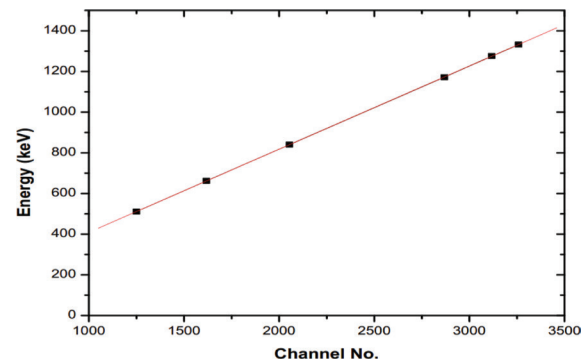

Figure 3: Calibration curve of HPGe detector

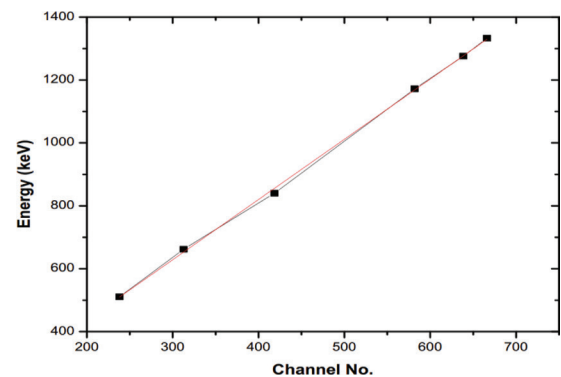

Figure 4: Measurements using HPGe detector

$$N_T = \frac{m N_A}{A_M} \quad (2)$$

Here m is the weight of the indium foil, N_A is the Avogadro's number and A_M is atomic mass of the indium foil. We have determined the efficiency of the detector using the following equation [8, 9].

$$\epsilon = G \times I \times M \quad (3)$$

Where G is the geometrical factor and I is the fraction of the photons transmitted by the intervening materials that reach the detector surface, M is the fraction of the photons absorbed by the detector. The geometrical factor G for right circular cylinder is given by;

$$G = \frac{\pi R^2}{4\pi R^2} \quad (4)$$

Where πR^2 is area of detector face and $4\pi R^2$ is the area of a sphere with a radius equal to the source to detector distance. There are losses due to air medium in the path of the particles and detector window. The intensity of the photons after considering all the losses is given by

$$I = e^{-\mu_{\text{air}} d_{\text{air}}} \times e^{-\mu_{\text{window}} d_{\text{window}}} \quad (5)$$

where μ_{air} linear attenuation coefficient of air, d_{air} distance between source and detector, μ_{window} linear attenuation coefficient of detector window, and d_{window} is thickness of the detector window. The thickness of HPGe detector is not sufficient to stop the gamma radiations and therefore the quantity M is given by

$$\Phi_{\text{th}} = \frac{N_o \lambda}{N_T \sigma_{\text{th}} \varepsilon G_{\text{th}} g I_{\gamma} (1 - e^{-\lambda t_i}) e^{-\lambda t_d} (1 - e^{-\lambda t_c})} \quad (6)$$

where μ is the linear attenuation coefficient for the HPGe crystal and d is the thickness of the crystal. The parameters related the efficiency calculation for HPGe detector is given in Table 3. Using these parameters, efficiency of HPGe detector has been estimated and found to 0.10. Using N_o , N_T and other quantities, we have determined the neutron flux and it comes out to be 1.2 n/cm² second.

Table 3: Efficiency parameters for HPGe and NaI(Tl) detectors

Geometric specifications	HPGe Detector	NaI(Tl) Detector
Distance between source and detector (d)	3 [cm]	0.8 [cm]
Entrance window thickness	0.05 [cm]	0.05 [cm]
μ_{Window}	0.1152 [cm ⁻¹]	0.1835 [cm ⁻¹]
μ_{Air}	0.0907 [cm ⁻¹]	0.0907 [cm ⁻¹]
Crystal thickness	4.71 [cm]	5 [cm]
μ_{Crystal}	0.3471 [cm ⁻¹]	0.3002 [cm ⁻¹]

3.2 Thermal neutron flux measurement using NaI(Tl) detectors

We have used NaI(Tl) detector spectrometer having crystal dimension of 2 inch X 2 inch for determine the thermal neutron flux. Here the detector window is covered with aluminum foil having thickness of 0.1 cm. Energy resolution of the detector is 60 keV at 662 keV. The experimental

arrangement is shown in Figure 2. We have calibrated the detector using the calibrated gamma sources of ¹³⁷Cs, ²²Na and ⁶⁰Co. The calibration curve is shown in Figure 5, and the calibration constant found to be 2.185 keV/Channel. Using this detector the flux of neutrons has been determined. The typical spectra of gamma radiation recorded by the NaI(Tl) detector without Cd and with Cd are shown in Figure 6. By measuring the intensity of gamma peaks, the flux of thermal neutrons is determined using the following equation for NaI(Tl) detector [4].

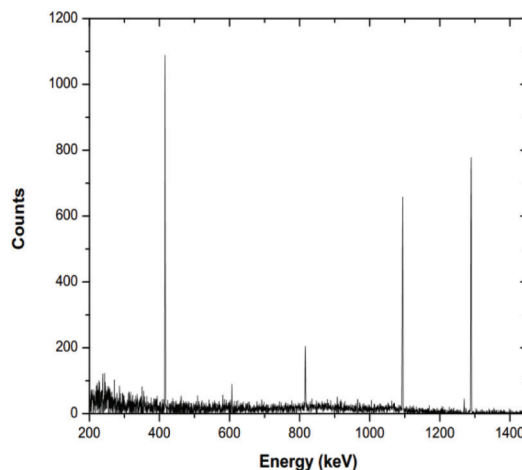

(a) The spectrum of ¹¹⁵In without Cd foil irradiation

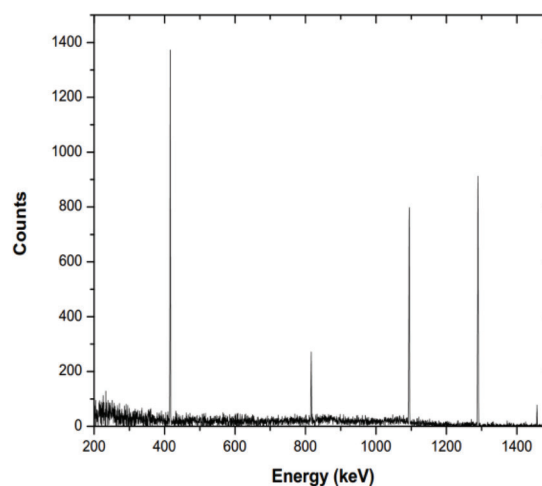

(b) The spectrum of ¹¹⁵In with Cd foil irradiation

Figure 5: Calibration curve of Na

$$\Phi_{\text{th}} = \frac{N_o \lambda}{N_T \sigma_{\text{th}} \varepsilon G_{\text{th}} g I_{\gamma} (1 - e^{-\lambda t_i}) e^{-\lambda t_d} (1 - e^{-\lambda t_c})} \quad (7)$$

here the flux equation is same as for HPGe detector. However, the new correction factor, g is known as the Westcott factor

which takes into account the temperature dependence of flux from the target which is given by 1.019 for indium target [10]. The G_{th} is the thermal neutron self shielding factor in the given irradiating foil [11, 12].

While determining the efficiency of the detector we have used the parameters given in table 3. By knowing the experimental N_O , the theoretical N_T and other parameters we have determined the neutron flux (Φ_{th}) and it comes out to be 1.4 n/cm²second.

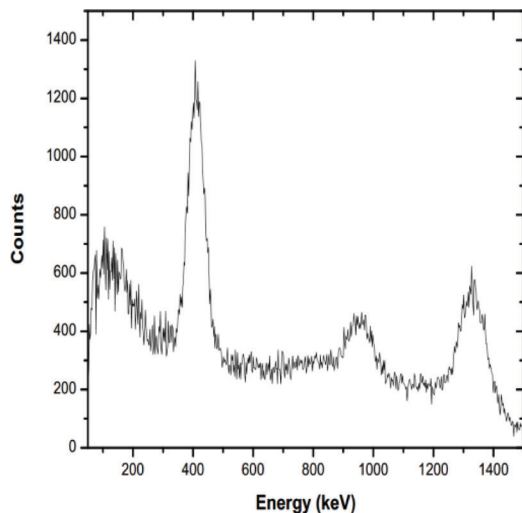

(a) The spectrum of ¹¹⁵In without Cd foil irradiation

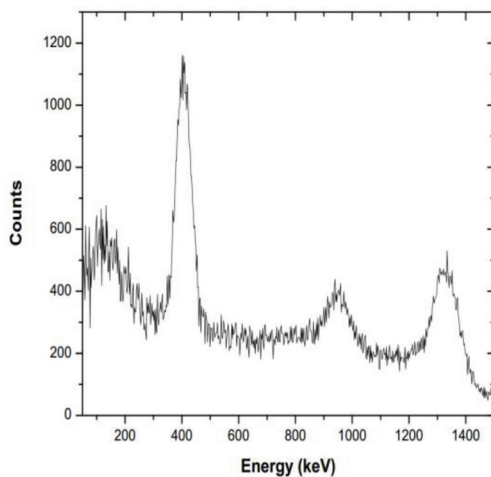

(b) The spectrum of ¹¹⁵In with Cd foil irradiation

Figure 6: Measurements using NaI(Tl) detector

Result and Discussion

In the present investigations, we have found that the N_O (1826 by HPGe, 8074 by NaI(Tl)), the decay constant λ is 0.0128 per minute, self shielding factor (G_{th}) is 0.489 and the Westcott factor is 1.019 for indium foil. By using these

values, as well as thermal neutron absorption cross section of 202 barns [13] and the detector efficiency, we have determined the thermal neutron flux (Φ_{th}) and it comes out to be the average of 1.3 n/cm² second using low and high resolution detectors. From these results we may say that the number of thermal neutrons from Am-Be source incident on the foil in per unit area per second is 1.

Conclusions

Thermal neutron flux of Am-Be source has been determined by detecting gamma rays emitted from activated indium foil using low resolution NaI(Tl) and high resolution HPGe detectors. It results; the average thermal neutron flux comes out to be 1.3 n/cm² second by adopting the foil difference method. This indicates that the flux is independent of the type of the detector used and the resolution of the detector. Therefore the researchers who do not have HPGe detectors, they may use NaI(Tl) detector for measuring the thermal neutron flux (Φ_{th}) of radioactive sources.

References

- [1] K. S Krane, Introductory nuclear physics, John Wiley & Sons publication's: New York, (1988).
- [2] I. Murata et al., Progress in Nuclear Science and Technology **4**, 345 (2014). <https://doi.org/10.15669/pnst.4.345>.
- [3] T. S. Mudhole and N. Umakantha, American Journal of Physics **43**, 104 (1975). <https://doi.org/10.1119/1.10038>.
- [4] P. Akhlaghi et al., Pramana-Journal of Physics **80**, 873 (2013). <https://doi.org/10.1007/s12043-013-0524-5>.
- [5] S. S. Grazhulene et al., Journal of Radioanalytical and Nuclear Chemistry **158**, 149 (1992). <https://doi.org/10.1007/BF02034781>.
- [6] H. Kluge and K. Weise, Radiation protection dosimetry **2**, 85 (1982). <https://doi.org/10.1093/oxfordjournals.rpd.a080571>.
- [7] A. Trkov et al., Nuclear Instruments and Methods in Physics Research A. **610**, 553 (2009). <https://doi.org/10.1016/j.nima.2009.08.079>.
- [8] E. D. Klhma and R. H. Ritchie, Physics Review **87**, 167 (1952). <https://doi.org/10.1103/PhysRev.87.167>.
- [9] B. Dahmani and A. Kadum, International Journal of Technology Enhancement and Emerging Engineering Research **2**, 45 (2014).
- [10] IAEA, International Atomic Energy Agency Vienna, (2007).

- [11] G. Wurdianto et al., Journal of Nuclear Science and Technology **32**, 1090 (1995). <https://doi.org/10.1080/18811248.1995.9731823>.
- [12] I. F. Goncalves et al., Journal of Radioanalytical and Nuclear Chemistry **261**, 637 (2004). <https://doi.org/10.1023/B:JRNC.0000037107.17274.16>.
- [13] K. W. Geiger and L. Van Der Zwan, Nuclear Instruments and Methods **131**, 315 (1975). [https://doi.org/10.1016/0029-554X\(75\)90336-5](https://doi.org/10.1016/0029-554X(75)90336-5).



Journal of Nuclear Physics, Material Sciences, Radiation and Applications

Chitkara University, Saraswati Kendra, SCO 160-161, Sector 9-C,
Chandigarh, 160009, India

Volume 6, Issue 2

February 2019

ISSN 2321-8649

Copyright: [© 2019 N. M. Badiger et al.] This is an Open Access article published in Journal of Nuclear Physics, Material Sciences, Radiation and Applications (J. Nucl. Phy. Mat. Sci. Rad. A.) by Chitkara University Publications. It is published with a Creative Commons Attribution- CC-BY 4.0 International License. This license permits unrestricted use, distribution, and reproduction in any medium, provided the original author and source are credited.
